

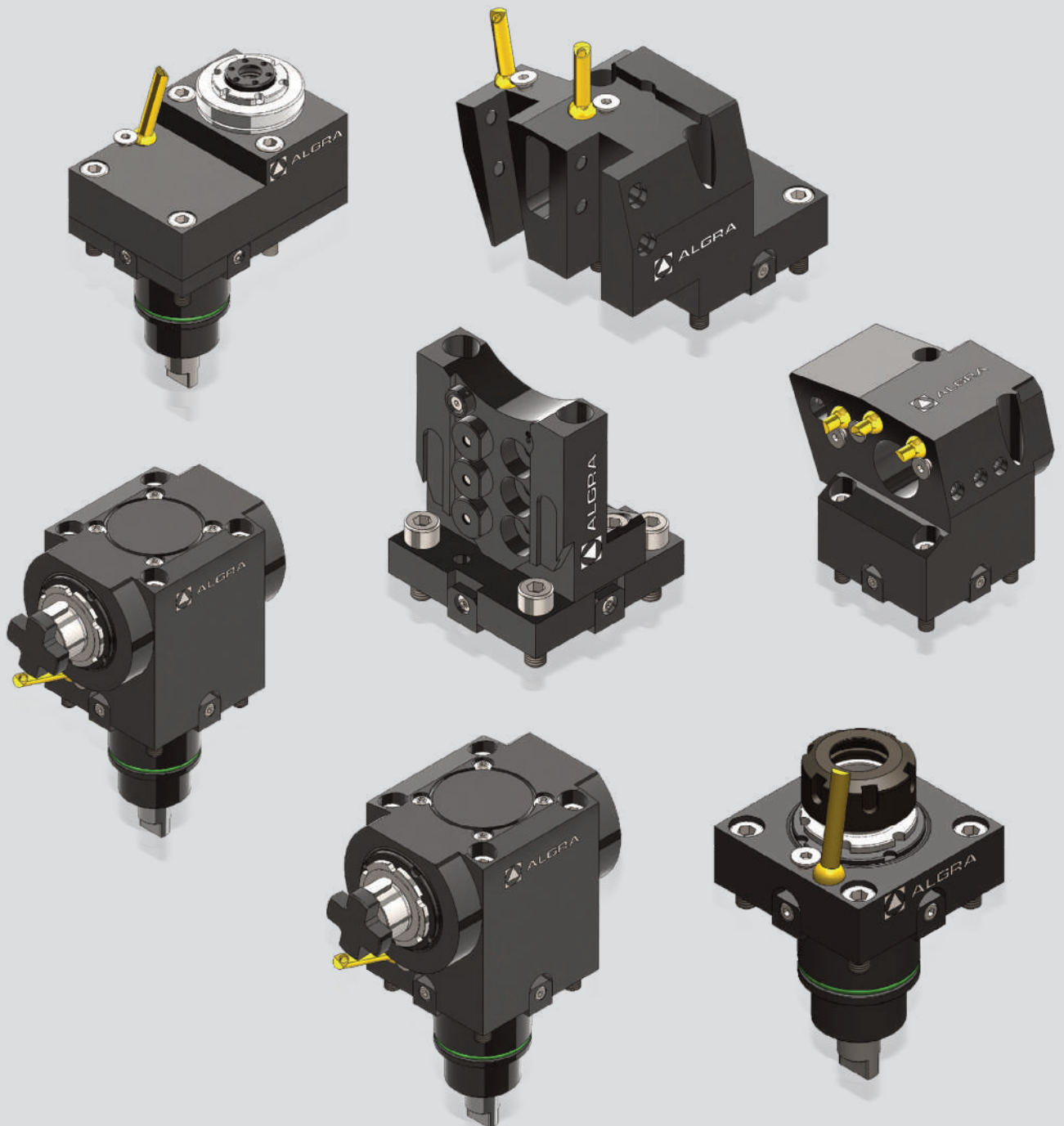











BMT45

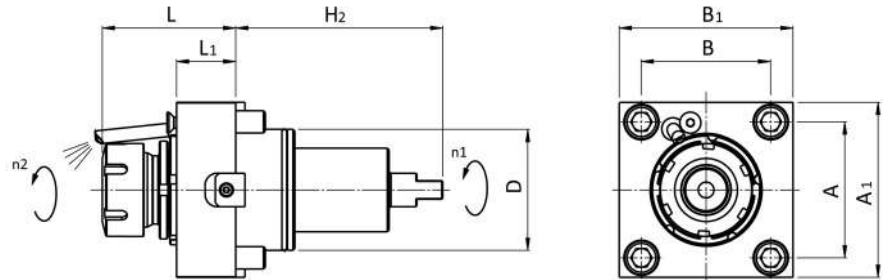

BMT45	Version	Tools Clamping	Center Height	Max. speed	Ratio	External	Internal	Page
	0°	ER25 - DIN6499		8000rpm	i=1:1	RAPPS 25 121UT45	RAPPS 25 131UT45	4
		ER32 - DIN6499		8000rpm	i=1:1	RAPPS 32 121UT45	RAPPS 32 131UT45	4
		ER16 - DIN6499		32000rpm	i=1:4	RAPPS 16 122UT45		5
		ER16 - DIN6499		16000rpm	i=1:2	RAPPD 16 1222UT45		5
	90°	ER25 - DIN6499	65mm	8000rpm	i=1:1	RRPPS 25 121UT45	RRPPS 25 131UT45	6
		ER25 - DIN6499	85mm	8000rpm	i=1:1	RRPPS 25 321UT45	RRPPS 25 331UT45	6
		ER25 - DIN6499	100mm	8000rpm	i=1:1	RRPPS 25 421UT45	RRPPS 25 431UT45	6
		ER32 - DIN6499	65mm	8000rpm	i=1:1	RRPPS 32 121UT45	RRPPS 32 131UT45	6
		ER16 - DIN6499	65mm	32000rpm	i=1:4	RRPPS 16 122UT45		7
		ER16 - DIN6499	65mm	16000rpm	i=1:2	RRPPS 16 1222UT45		7
		Ø16mm - DIN6358	65mm	8000rpm	i=1:1	RRPFS 16 121UT45		7
		Ø16mm - DIN6358	85mm	8000rpm	i=1:1	RRPFS 16 321UT45		7
Ø16mm - DIN6358	100mm	8000rpm	i=1:1	RRPFS 16 421UT45		7		
	90° Double	ER25 - DIN6499	65mm	8000rpm	i=1:1	RRPPT 25 121UT45		8
		ER25 - DIN6499	85mm	8000rpm	i=1:1	RRPPT 25 321UT45		8
		ER25 - DIN6499	100mm	8000rpm	i=1:1	RRPPT 25 421UT45		8
		ER32 - DIN6499	65mm	8000rpm	i=1:1	RRPPT 32 121UT45		8
	±90°	ER20 - DIN6499		8000rpm	i=1:1	ROPPS 20 121UT45	ROPPS 20 131UT45	9





BMT45	Version	Tools Clamping	Center Height	Coolant	ALGRA Part No.	Page
	O.D. cutting holder	□ 20mm	H:65mm	External	E10/U 20 T45X65	10
		□ 0.75"	H:65mm	External	E10/U 0.75" T45X65	10
	O.D. double holder	□ 20mm	H:85mm	External	E10/UD 20 T45X85	10
		□ 0.75"	H:85mm	External	E10/UD 0.75" T45X85	10
	Face and I.D. cutting holder	□ 20mm	H:60mm	External	E10/UA 20 T45X60	11
		□ 0.75"	H:60mm	External	E10/UA 0.75" T45X60	11
		□ 20mm	H:90mm	External	E10/UA 20 T45X90	11
		□ 0.75"	H:90mm	External	E10/UA 0.75" T45X90	11
	Blade Holder	⌀ 26mm	H:90mm	External	E10/TT 26 T45X90	11
	Index cutting holder	□ 20mm	H:85mm	External	E12/IDS20 T45X85	12
		□ 0.75"	H:85mm	External	E10/IDS0.75" T45X85	12
	Boring Bar holder	∅ 32mm	H:65mm	Int/Ext	E10/B 32 T45X65	12
		∅ 1.25"	H:65mm	Int/Ext	E10/B 1.25" T45X65	12
		∅ 25mm	H:80mm	Int/Ext	E10/B 25 T45X80	12
		∅ 32mm	H:80mm	Int/Ext	E10/B 32 T45X80	12
		∅ 0.75"	H:80mm	Int/Ext	E10/B 0.75" T45X80	12
		∅ 1.25"	H:80mm	Int/Ext	E10/B 1.25" T45X80	12
	Boring Bar holder	∅ 20mm	H:80mm	Int/Ext	E10/BN 20 T45X80	12
		∅ 0.75"	H:80mm	Int/Ext	E10/BN 0.75" T45X80	12
	Boring Bar holder	∅ 25mm	H:50mm/90mm	Int/Ext	E10/BD 25 T45X50/90	13
		∅ 1"	H:50mm/90mm	Int/Ext	E10/BD 1" T45X50/90	13
	Boring Bar holder	∅ 25mm	H:50mm/90mm	Int/Ext	E10/BDN25 T45X50/90	13
		∅ 1"	H:50mm/90mm	Int/Ext	E10/BDN1" T45X50/90	13
	Index Boring Bar holder	∅ 32mm/16mm	H:65mm	Int/Ext	E12/IBD32/16 T45X65	14
		∅ 1.25"/0.5"	H:65mm	Int/Ext	E12/IBD1.25"/0.5" T45X65	14
	Boring Bar holder	∅ 20mm	H:50mm/75mm/100mm	Int/Ext	E10/BQ 20 T45X50/100	14
		∅ 0.75"	H:50mm/75mm/100mm	Int/Ext	E10/BQ 0.75" T45X50/100	14



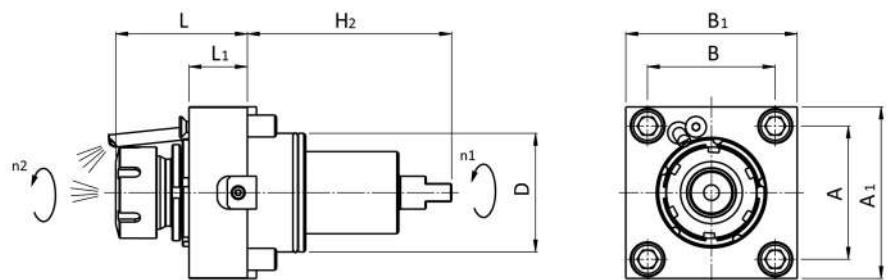
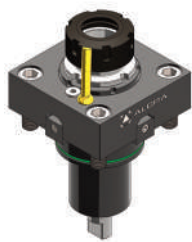



1/BMT45			Codice	D	ER	H	H1	H2	L	L1	L2	A	B	A1	B1	A2	B2	M ₂	n ₂	P
			code - code - Bestell Nr.						(min-max)									Nm	min-1	kW
0°			RAPPS 25 121UT45	45	25			84	53,5-57,2	25		58	58	75	75			35	8000	6
			RAPPS 32 121UT45	45	32			84	76,5-80,2	40		58	58	75	75				35	8000
																				

4

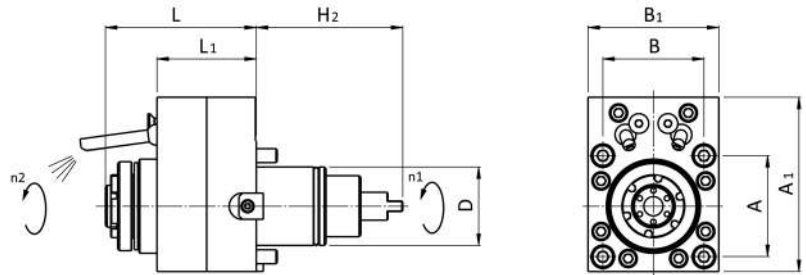





2/BMT45			Codice	D	ER	H	H1	H2	L	L1	L2	A	B	A1	B1	A2	B2	M ₂	n ₂	P
			code - code - Bestell Nr.						(min-max)									Nm	min-1	kW
0°			RAPPS 25 131UT45	45	25			84	53,5-57,2	25		58	58	75	75			35	8000	6
			RAPPS 32 131UT45	45	32			84	76,5-80,2	40		58	58	75	75				35	8000
																				
																				
																				

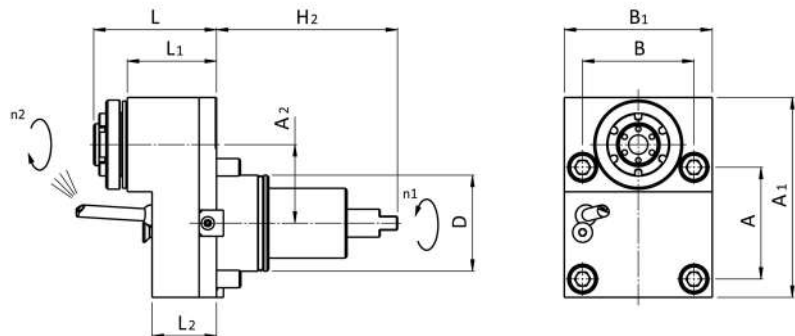





3/BMT45			Codice	D	ER	H	H1	H2	L	L1	L2	A	B	A1	B1	A2	B2	M ₂	n ₂	P
			code - code - Bestell Nr.						(min-max)									Nm	min-1	kW
  			RAPPS 16 122UT45	45	16			84	82,5-86,5	57		58	58	100	75			12	32000	3
																				

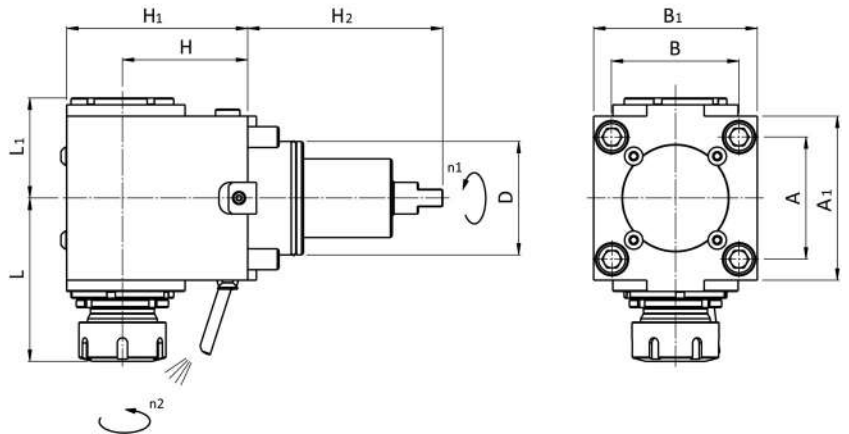





4/BMT45			Codice	D	ER	H	H1	H2	L	L1	L2	A	B	A1	B1	A2	B2	M ₂	n ₂	P
			code - code - Bestell Nr.						(min-max)									Nm	min-1	kW
  			RAPPD 16 1222UT45	45	16			84	66,8-70,5	51,3	37	58	58	109,5	75	45		15	16000	4
																				

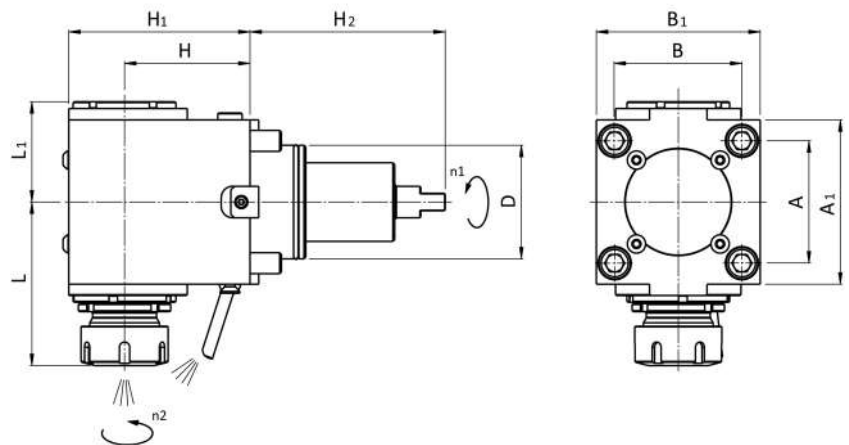

5/BMT45			Codice code - code - Bestell Nr.	D	ER	H	H1	H2	L (min-max)	L1	L2	A	B	A1	B1	A2	B2	M ₂ Nm	n ₂ min-1	P kW	
   -1 (1:1)	 EXTERNAL	RRPPS 25 121UT45	45	25	65	95	84	81,2-84,9	52,2			58	58	75	75			35	8000	6	
		RRPPS 32 121UT45	45	32	65	97	84	89,9-93,6	57,4				58	58	75	75			35	8000	6
		RRPPS 25 321UT45	45	25	85	115	84	81,2-84,9	52,2				58	58	75	75			35	8000	6
		RRPPS 25 421UT45	45	25	100	130	84	81,2-84,9	52,2				58	58	75	75			35	8000	6



6/BMT45			Codice code - code - Bestell Nr.	D	ER	H	H1	H2	L (min-max)	L1	L2	A	B	A1	B1	A2	B2	M ₂ Nm	n ₂ min-1	P kW	
   -1 (1:1)	 INT./EXT.	RRPPS 25 131UT45	45	25	65	95	84	81,2-84,9	52,2			58	58	75	75			35	8000	6	
		RRPPS 32 131UT45	45	32	65	97	84	89,9-93,6	63,4				58	58	75	75			35	8000	6
		RRPPS 25 331UT45	45	25	85	115	84	81,2-84,9	52,2				58	58	75	75			35	8000	6
		RRPPS 25 431UT45	45	25	100	130	84	81,2-84,9	52,2				58	58	75	75			35	8000	6

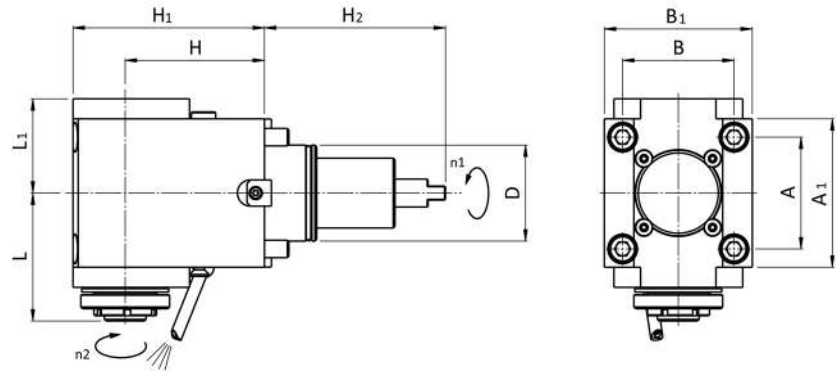

7/BMT45		Codice	D	ER	H	H1	H2	L	L1	L2	A	B	A1	B1	A2	B2	M ₂	n ₂	P
		code - code - Bestell Nr.						(min-max)									Nm	min-1	kW
		RRPPS 16 122UT45	45	16	65	95	84	66-69,7	52,5		58	58	75	75			12	32000	3

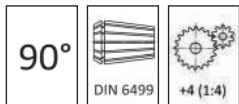



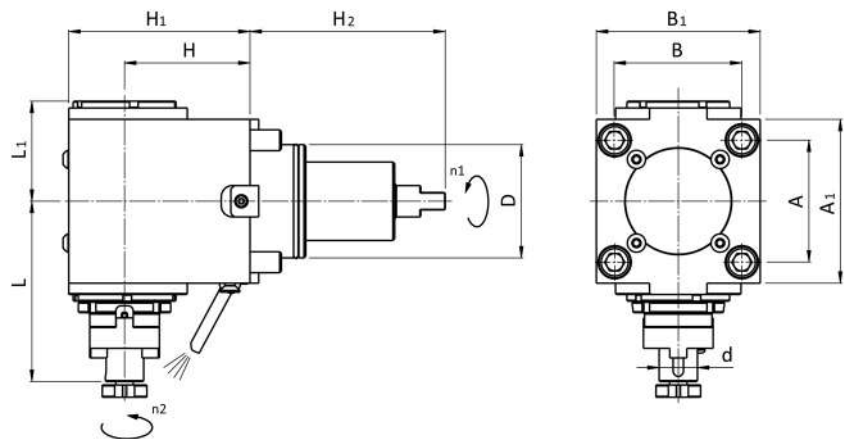
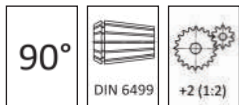

7/BMT45		Codice	D	ER	H	H1	H2	L	L1	L2	A	B	A1	B1	A2	B2	M ₂	n ₂	P
		code - code - Bestell Nr.						(min-max)									Nm	min-1	kW
		RRPPS 16 1222UT45	45	16	65	95	84	69,6-73,3	54		58	58	75	75			15	16000	4



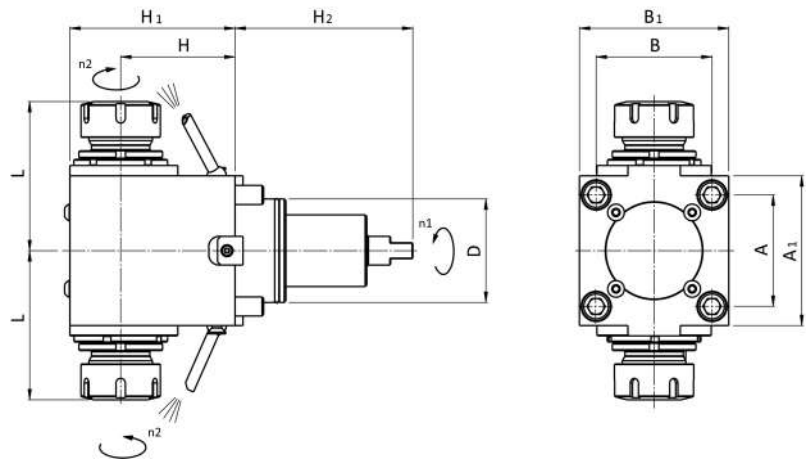



8/BMT45		Codice	D	d	H	H1	H2	L	L1	L2	A	B	A1	B1	A2	B2	M ₂	n ₂	P
		code - code - Bestell Nr.															Nm	1	kW
		RRPFS 16 121UT45	45	Ø16	65	95	84	95	52,2		58	58	75	75			35	8000	6
		RRPFS 16 321UT45	45	Ø16	85	115	84	95	52,2		58	58	75	75			35	8000	6
		RRPFS 16 421UT45	45	Ø16	100	130	84	95	52,2		58	58	75	75			35	8000	6



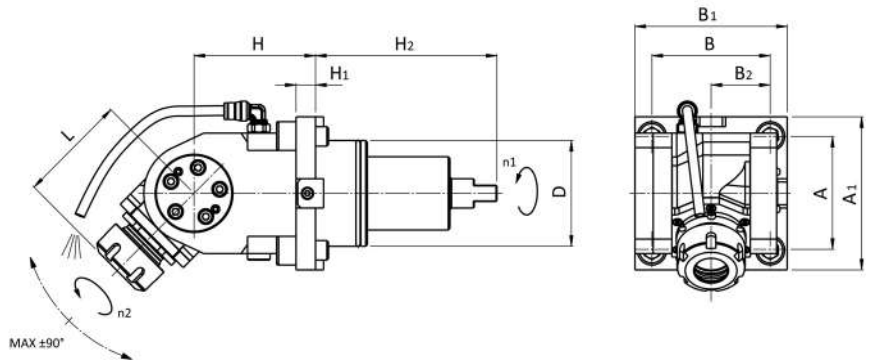





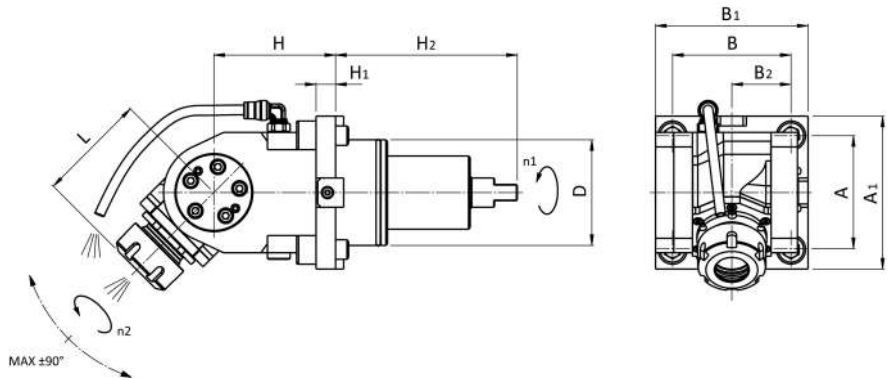

9/BMT45		Codice code - code - Bestell Nr.	D	ER	H	H1	H2	L (min-max)	L1	L2	A	B	A1	B1	A2	B2	M ₂ Nm	n ₂ min-1	P kW
   ±1 (1:1)	 EXTERNAL	RRPPT 25 121UT45	45	25	65	95	84	81,2-84,9			58	58	75	75			35	8000	6
		RRPPT 32 121UT45	45	32	65	97	84	89,9-93,6			58	58	75	75			35	8000	6
		RRPPT 25 321UT45	45	25	85	115	84	81,2-84,9			58	58	75	75			35	8000	6
		RRPPT 25 421UT45	45	25	100	130	84	81,2-84,9			58	58	75	75			35	8000	6





10/BMT45			Codice	D	ER	H	H1	H2	L	L1	L2	A	B	A1	B1	A2	B2	M ₂	n ₂	P	
			code - code - Bestell Nr.						(min-max)									Nm	min-1	kW	
±90°			ROPPS 20 121UT45	45	20	65	12	84	48,8-52,5			58	58	75	75		29	15	8000	3	
																					



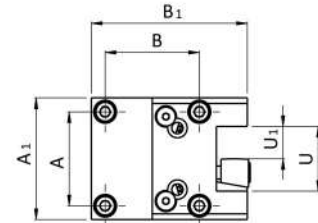
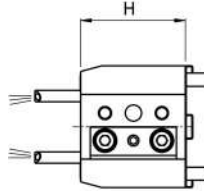

11/BMT45			Codice	D	ER	H	H1	H2	L	L1	L2	A	B	A1	B1	A2	B2	M ₂	n ₂	P	
			code - code - Bestell Nr.						(min-max)									Nm	min-1	kW	
±90°			ROPPS 20 131UT45	45	20	65	12	84	48,8-52,5			58	58	75	75		29	15	8000	3	
																					



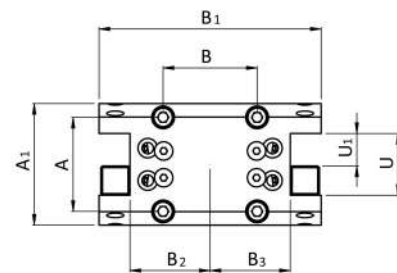
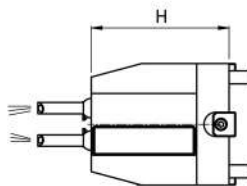

101/BMT45		Codice code - code - Bestell Nr.	U	U1	U2	H	H1	H2	H3	A	B	A1	B1	A2	B2	B3
  EXTERNAL	E10/U 20 T45X65		40	20		65				58	58	75	96			
	E10/U 0.75" T45X65		1.5"	0.75"		65				58	58	75	96			



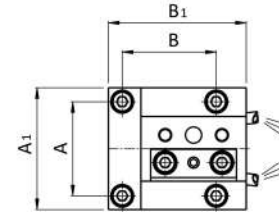
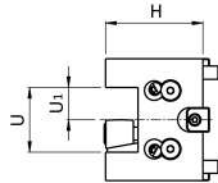

102/BMT45		Codice code - code - Bestell Nr.	U	U1	U2	H	H1	H2	H3	A	B	A1	B1	A2	B2	B3
  EXTERNAL	E10/UD 20 T45X85		40	20		85				58	58	75	137		49,5	49,5
	E10/UD 0.75" T45X85		1.5"	0.75"		85				58	58	75	137		49,5	49,5



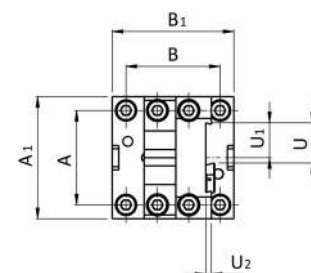
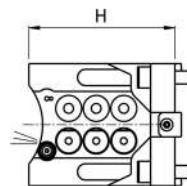

103/BMT45		Codice code - code - Bestell Nr.	U	U1	U2	H	H1	H2	H3	A	B	A1	B1	A2	B2	B3
 		E10/UA 20 T45X60	40	20		60				58	58	75	85			
		E10/UA 0.75" T45X60	1.5"	0.75"		60				58	58	75	85			
		E10/UA 20 T45X90	40	20		90				58	58	75	85			
		E10/UA 0.75" T45X90	1.5"	0.75"		90				58	58	75	85			



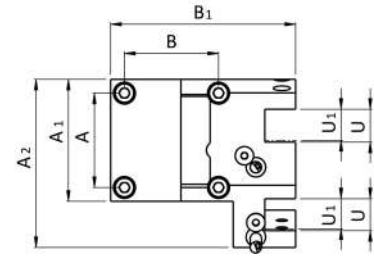
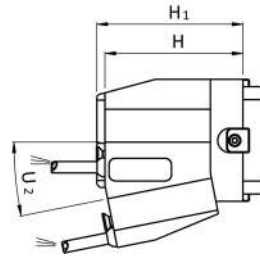

104/BMT45		Codice code - code - Bestell Nr.	U	U1	U2	H	H1	H2	H3	A	B	A1	B1	A2	B2	B3
 		E10/TT 26 T45X90	26	21	2,36	90				58	58	75	75			



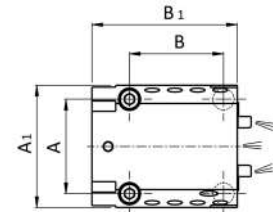
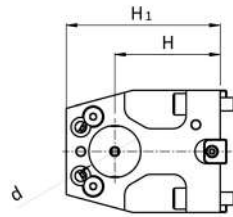

105/BMT45	Codice code - code - Bestell Nr.	U	U1	U2	H	H1	H2	H3	A	B	A1	B1	A2	B2	B3
	E12/IDS20 T45X85	20,5	20	11,25°	85	90			58	58	75	114	103,5		
 EXTERNAL	E12/IDS0.75" T45X85	20,5	0.75"	11,25°	85	90			58	58	75	114	103,5		



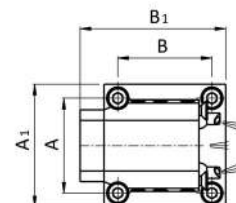
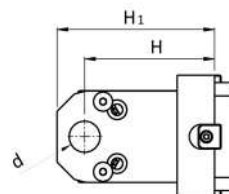

12

106/BMT45	Codice code - code - Bestell Nr.	d	d1	d2	H	H1	H2	H3	A	B	A1	B1	A2	B2	B3
	E10/B 32 T45X65	∅ 32			65	95			58	58	75	90			
 INT./EXT.	E10/B 1.25" T45X65	∅ 1.25"			65	95			58	58	75	90			
	E10/B 25 T45X80	∅ 25			80	110			58	58	75	90			
	E10/B 32 T45X80	∅ 32			80	110			58	58	75	90			
	E10/B 0.75" T45X80	∅ 0.75"			80	110			58	58	75	90			
	E10/B 1.25" T45X80	∅ 1.25"			80	115			58	58	75	90			



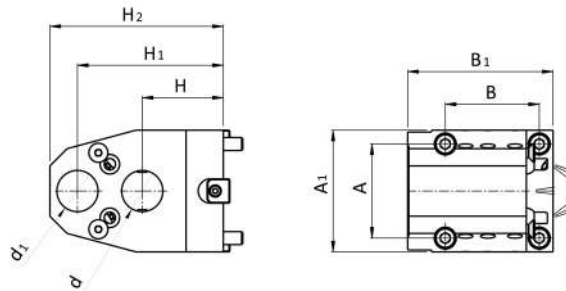

107/BMT45	Codice code - code - Bestell Nr.	d	d1	d2	H	H1	H2	H3	A	B	A1	B1	A2	B2	B3
	E10/BN 20 T45X80	∅ 20			80	100			58	58	75	90			
 INT./EXT.	E10/BN 0.75" T45X80	∅ 0.75"			80	100			58	58	75	90			



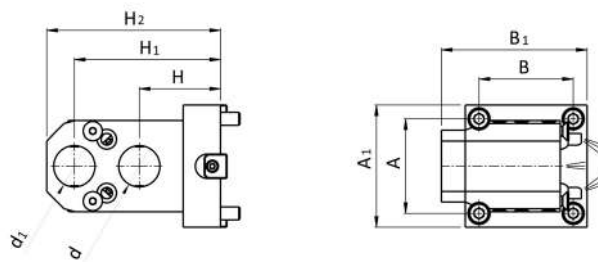

108/BMT45		Codice code - code - Bestell Nr.	d	d1	d2	H	H1	H2	H3	A	B	A1	B1	A2	B2	B3
  INT./EXT.	E10/BD 25 T45X50/90		Ø 25	Ø 25		50	90	107		58	58	75	90			
	E10/BD 1" T45X50/90		Ø 1"	Ø 1"		50	90	107		58	58	75	90			



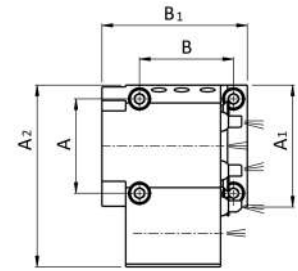
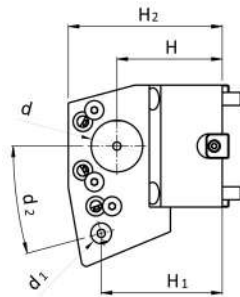

109/BMT45		Codice code - code - Bestell Nr.	d	d1	d2	H	H1	H2	H3	A	B	A1	B1	A2	B2	B3
  INT./EXT.	E10/BDN25 T45X50/90		Ø 25	Ø 25		50	90	107		58	58	75	90			
	E10/BDN1" T45X50/90		Ø 1"	Ø 1"		50	90	107		58	58	75	90			

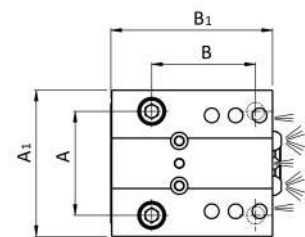
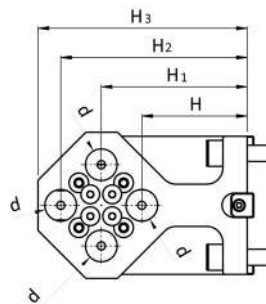

110/BMT45		Codice code - code - Bestell Nr.	d	d1	d2	H	H1	H2	H3	A	B	A1	B1	A2	B2	B3
  INT./EXT.		E12/IBD32/16 T45X65	Ø 32	Ø 16	15°	65	75	95		58	58	75	90	112		
		E12/IBD1.25"/0.5" T45X65	Ø 1.25"	Ø 0.5"	15°	65	75	95		58	58	75	90	112		



111/BMT45		Codice code - code - Bestell Nr.	d	d1	d2	H	H1	H2	H3	A	B	A1	B1	A2	B2	B3
  INT./EXT.		E10/BQ 20 T45X50/100	Ø 20			50	75	100	115	58	58	90	100			
		E10/BQ 0.75" T45X50/100	Ø 0.75"			50	75	100	115	58	58	90	100			

**La produzione:
il lavoro**
Production:
work

La produzione viene sviluppata nella moderna struttura a temperatura controllata di Almenno San Salvatore, mentre negli stabilimenti di Brembilla (I-Bergamo) vengono effettuate le lavorazioni di montaggio ed assemblaggio di gruppi completi. La superficie coperta delle strutture è di mq. 15.000, dei quali mq. 1.000 sono adibiti agli uffici amministrativi, commerciali e tecnici. L'attività produttiva si svolge con l'utilizzo di impianti e macchinari CNC costantemente aggiornati alle nuove tecnologie ed in grado di sviluppare le seguenti lavorazioni:

- Asportazione di truciolo
- Elettroerosione
- Tornitura orizzontale e verticale
- Fresatura universale 5 assi
- Fresatura/tornitura
- Lappatura per fori e piani
- Rettifica in tondo interno ed esterno
- Rettifica in tangenziale oltre al montaggio di gruppi e sottogruppi completi.

The production is developed in the modern, temperature controlled facility in Almenno San Salvatore, with Brembilla factories there are the assembly operations and the assembly of complete groups. The facilities covered area is of 15,000 sqm., 1,000 sqm. of which are used for the administrative commercial and technical offices. The production cycle takes place with the use of CNC fixtures and equipment constantly updated with new technologies and able to develop the following machining:

- Chip machining
- Electroerosion
- Horizontal and vertical turning
- 5-axis universal milling
- Milling/turning
- Lapping for holes and plane surfaces
- Cylindrical internal and external grinding
- Tangential grinding in addition to the assembly of complete groups and subassemblies.

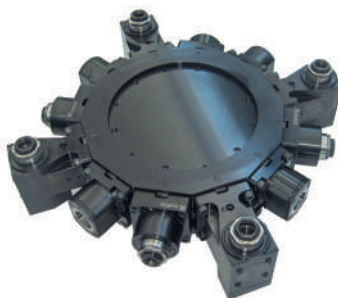

**Certificazioni:
uno standard
qualitativo**
Certification:
a quality
standard

La tecnologia avanzata svolge un ruolo chiave nell'obiettivo di incrementare il proprio valore, quello dei propri prodotti, dei servizi e della capacità del personale, operando nel rispetto delle norme UNI EN ISO 9001:2008 e ISO 14001:2004. L'alto livello di sensibilità verso il rispetto delle regole di sicurezza e dell'ambiente è presente ed immediatamente percepito in tutte le strutture aziendali.

Advanced technology plays a key role aiming to increase its value and the products, services and staff capacity value, operating in compliance with UNI EN ISO 9001:2008 and ISO 14001:2004.

The high level of sensitivity towards the observance of safety rules and the environment is present and perceived immediately in all facilities.



UNI EN ISO 9001:2008 - Cert. n° 0141

UNI EN ISO 14001:2004 - Cert. n° 0270A



ALGRA S.p.A. Divisione accessori
Via Manzoni, 41 24031 Almenno S. Salvatore (BG)
Tel. +39 035.64.20.51 • Fax +39 035.64.01.28
algra.accessori@algra.it - www.algra.it