

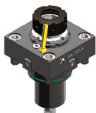













BMT65

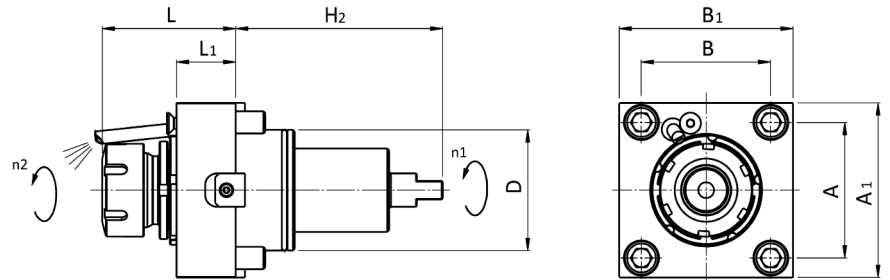
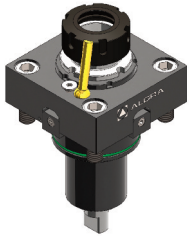

BMT65	Version	Tools Clamping	Center Height	Max. speed	Ratio	External	Internal	Page
	0°	ER32 - DIN6499 ER20 - DIN6499 ER20 - DIN6499		6000rpm 24000rpm 12000rpm	i=1:1 i=1:4 i=1:2	RAPPS 32 121UT65 RAPPS 20 122UT65 RAPPD 20 1222UT65	RAPPS 32 131UT65	4 5 5
	90°	ER32 - DIN6499 ER32 - DIN6499 ER20 - DIN6499 ER20 - DIN6499 Ø22mm - DIN6358 Ø22mm - DIN6358	72mm 100mm 72mm 72mm 72mm 100mm	6000rpm 6000rpm 24000rpm 12000rpm 6000rpm 6000rpm	i=1:1 i=1:1 i=1:4 i=1:2 i=1:1 i=1:1	RRPPS 32 121UT65 RRPPS 32 321UT65 RRPPS 20 122UT65 RRPPS 20 1222UT65 RRPFS 22 121UT65 RRPFS 22 321UT65	RRPPS 32 131UT65 RRPPS 32 331UT65	6 6 7 7 7 7
	90° Double	ER32 - DIN6499 ER32 - DIN6499	72mm 100mm	6000rpm 6000rpm	i=1:1 i=1:1	RRPPT 32 121UT65 RRPPT 32 321UT65		8 8
	±90°	ER25 - DIN6499		6000rpm	i=1:1	ROPPS 25 121UT65	ROPPS 25 131UT65	9







BMT65	Version	Tools Clamping	Center Height	Coolant	ALGRA Part No.	Page
	O.D. cutting holder	□ 25mm	H:80mm	External	E10/U 25 T65X80	10
		□ 1"	H:80mm	External	E10/U 1" T65X80	10
	O.D. double holder	□ 25mm	H:80mm	External	E10/UD 25 T65X80	10
		□ 1"	H:80mm	External	E10/UD 1" T65X80	10
	O.D. Y-axis double toolholders for both spindle	□ 20mm	H:75mm	External	E10/UQ 20 T65X75	11
	Face and I.D. cutting holder	□ 25mm	H:70mm	External	E10/UA 25 T65X70	11
		□ 1"	H:70mm	External	E10/UA 1" T65X70	11
	Blade Holder	∅ 32mm	H:80mm	External	E10/TT 32 T65X80	12
	Boring Bar holder	∅ 40mm	H:72mm	Int/Ext	E10/B 40 T65X72	12
		∅ 50mm	H:72mm	Int/Ext	E10/B 50 T65X72	12
		∅ 1.5"	H:72mm	Int/Ext	E10/B 1.5" T65X72	12
		∅ 2"	H:72mm	Int/Ext	E10/B 2" T65X72	12
		∅ 40mm	H:100mm	Int/Ext	E10/B 40 T65X100	12
		∅ 1.5"	H:100mm	Int/Ext	E10/B 1.5" T65X100	12
		∅ 40mm	H:115mm	Int/Ext	E10/B 40 T65X115	12
		∅ 1.5"	H:115mm	Int/Ext	E10/B 1.5" T65X115	12

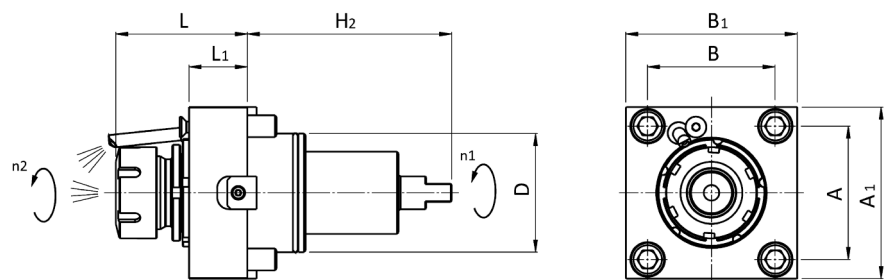
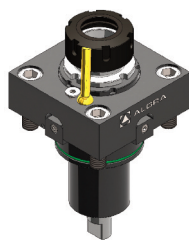





1/BMT65			Codice	D	ER	H	H1	H2	L	L1	L2	A	B	A1	B1	A2	B2	M ₂	n ₂	P
			code - code - Bestell Nr.						(min-max)									Nm	min-1	kW
  			RAPPS 32 121UT65	65	32			112	68,5-72,2	32		73	70	94	94			70	6000	10
																				

4

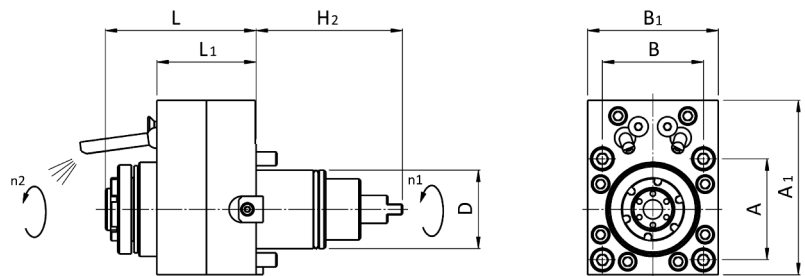



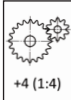

2/BMT65			Codice	D	ER	H	H1	H2	L	L1	L2	A	B	A1	B1	A2	B2	M ₂	n ₂	P
			code - code - Bestell Nr.						(min-max)									Nm	min-1	kW
  			RAPPS 32 131UT65	65	32			112	68,5-72,2	32		73	70	94	94			70	6000	10
  																				

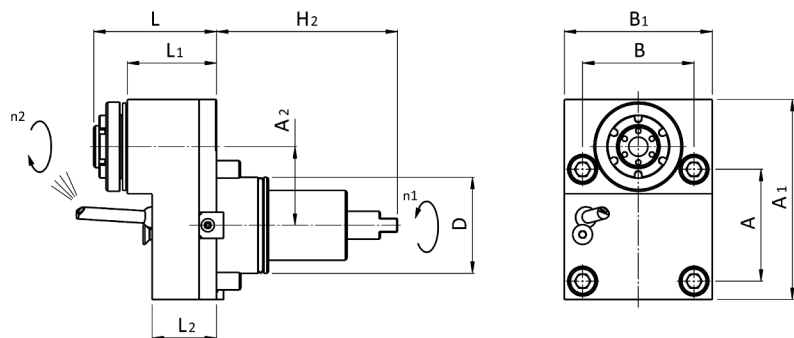



3/BMT65		Codice	D	ER	H	H1	H2	L	L1	L2	A	B	A1	B1	A2	B2	M ₂	n ₂	P	
		code - code - Bestell Nr.						(min-max)									Nm	min-1	kW	
  		RAPPS 20 122UT65	65	20			112	122,5-126,2	96			70	73	120	94			20	24000	8
																				



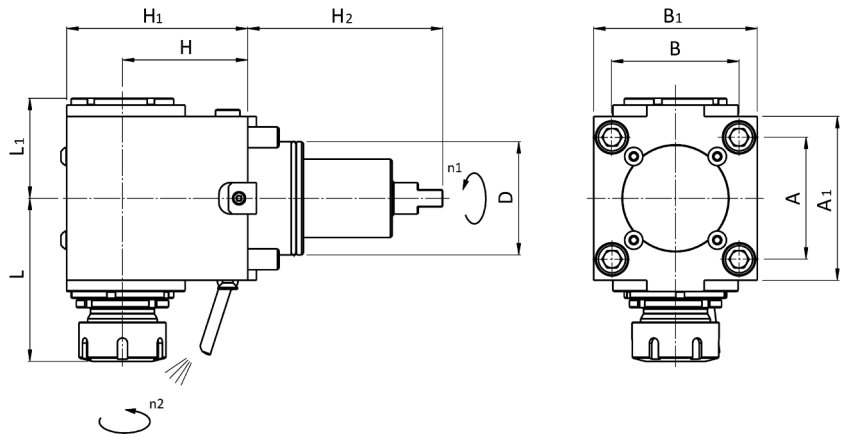





4/BMT65		Codice	D	ER	H	H1	H2	L	L1	L2	A	B	A1	B1	A2	B2	M ₂	n ₂	P	
		code - code - Bestell Nr.						(min-max)									Nm	min-1	kW	
  		RAPPD 20 1222UT65	65	20			112	101,3-105	71	52	70	73	122	94	45		35	12000	8	
																				

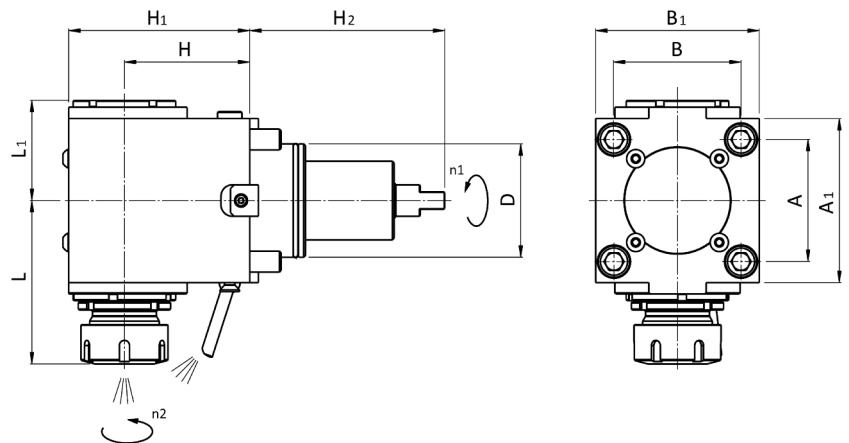





5/BMT65			Codice code - code - Bestell Nr.	D	ER	H	H1	H2	L (min-max)	L1	L2	A	B	A1	B1	A2	B2	M ₂ Nm	n ₂ min-1	P kW
90°			RRPPS 32 121UT65	65	32	72	104	112	89,9-93,6	57,4		70	73	94	94			70	6000	10
			RRPPS 32 321UT65	65	32	100	132	112	89,9-93,6	57,4		70	73	94	94				70	6000
																				

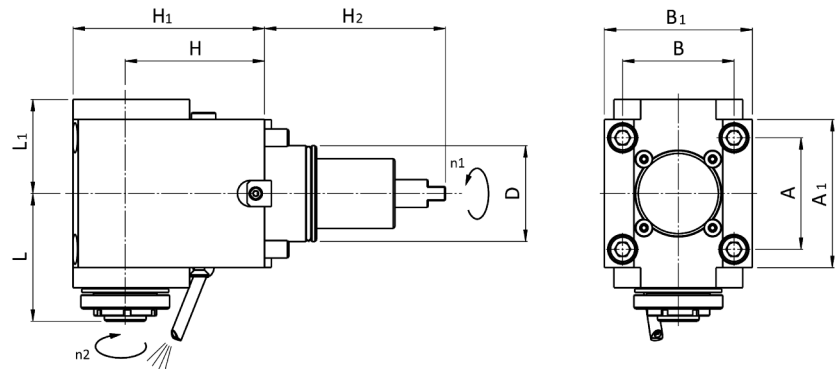

6







6/BMT65			Codice code - code - Bestell Nr.	D	ER	H	H1	H2	L (min-max)	L1	L2	A	B	A1	B1	A2	B2	M ₂ Nm	n ₂ min-1	P kW
90°			RRPPS 32 131UT65	65	32	72	104	112	89,9-93,6	63,4		70	73	94	94			70	6000	10
			RRPPS 32 331UT65	65	32	100	132	112	89,9-93,6	63,4		70	73	94	94				70	6000
																				
																				
																				



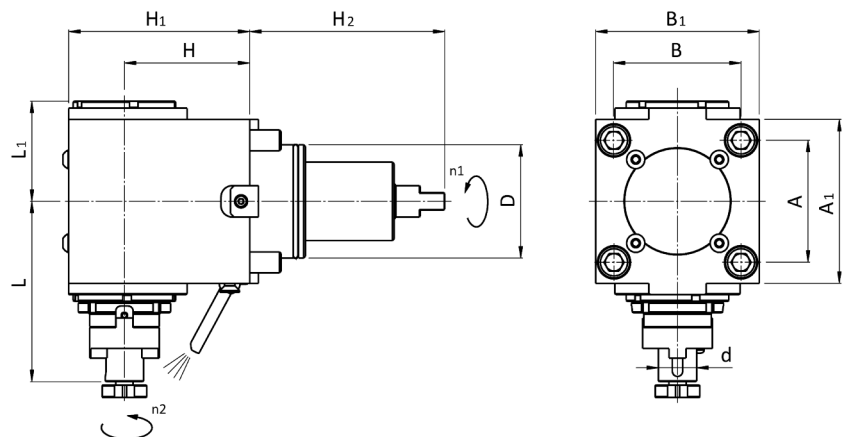



7/BMT65		Codice code - code - Bestell Nr.	D	ER	H	H1	H2	L (min-max)	L1	L2	A	B	A1	B1	A2	B2	M ₂ Nm	n ₂ min-1	P kW
90°	  DIN 6499 +4 (1:4)	RRPPS 20 122UT65	65	20	72	112	112	89,9-93,6	57,4		70	73	94	94			20	24000	8
	EXTERNAL																		

7/BMT65		Codice code - code - Bestell Nr.	D	ER	H	H1	H2	L (min-max)	L1	L2	A	B	A1	B1	A2	B2	M ₂ Nm	n ₂ min-1	P kW
90°	  DIN 6499 +2 (1:2)	RRPPS 20 1222UT65	65	20	72	104	112	89,9-93,6	57,4		70	73	94	94			35	12000	8
	EXTERNAL																		

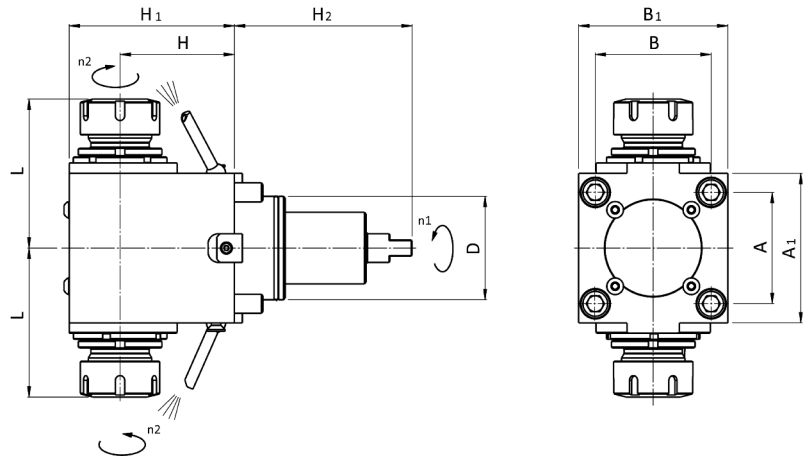





8/BMT65		Codice code - code - Bestell Nr.	D	d	H	H1	H2	L	L1	L2	A	B	A1	B1	A2	B2	M ₂ Nm	n ₂ 1	P kW
90°	  DIN 6358 -1 (1:1)	RRPFS 22 121UT65	65	∅22	72	104	112	103,5	57,4		70	73	94	94			70	6000	10
	EXTERNAL	RRPFS 22 321UT65	65	∅22	100	132	112	103,5	57,4		70	73	94	94			70	6000	10

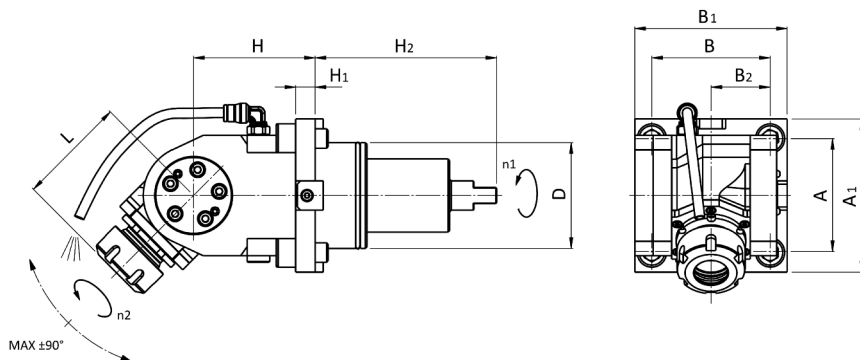





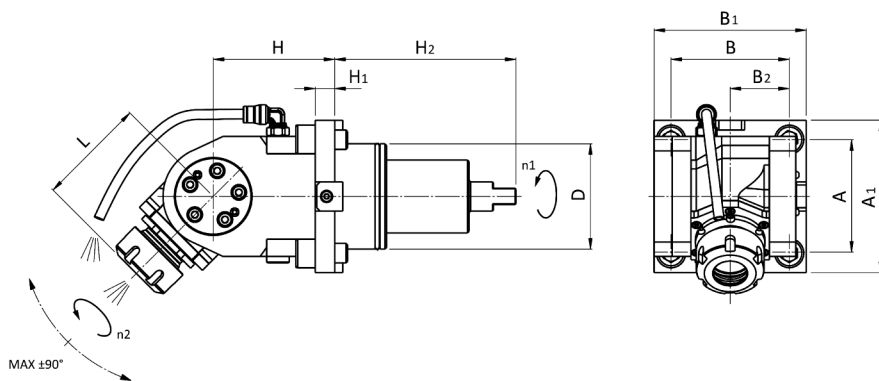
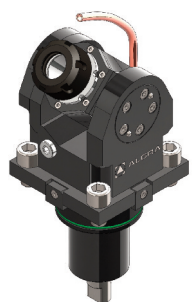

9/BMT65		Codice code - code - Bestell Nr.	D	ER	H	H1	H2	L (min-max)	L1	L2	A	B	A1	B1	A2	B2	M ₂ Nm	n ₂ min-1	P kW
 90°  DIN 6499  ±1 (1:1)	 EXTERNAL	RRPPT 32 121UT65	65	32	72	104	112	93-93,6			70	73	94	94			70	6000	10
		RRPPT 32 321UT65	65	32	100	132	112	93-93,6			70	73	94	94				70	6000





10/BMT65			Codice	D	ER	H	H1	H2	L	L1	L2	A	B	A1	B1	A2	B2	M ₂	n ₂	P
			code - code - Bestell Nr.						(min-max)									Nm	min-1	kW
  			ROPPS 25 121UT65	65	25	75	12	112	63,5-67,2			70	73	94	94		36,5	25	6000	4
																				



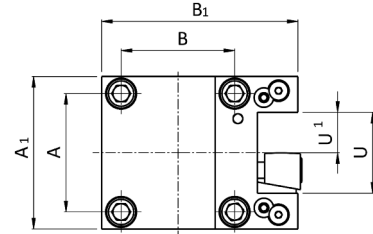
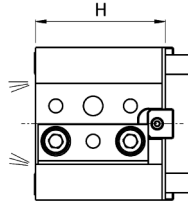
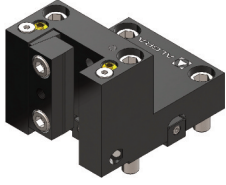

11/BMT65			Codice	D	ER	H	H1	H2	L	L1	L2	A	B	A1	B1	A2	B2	M ₂	n ₂	P
			code - code - Bestell Nr.						(min-max)									Nm	min-1	kW
  			ROPPS 25 131UT65	65	25	75	12	112	63,5-67,2			70	73	94	94		36,5	25	6000	4
  																				



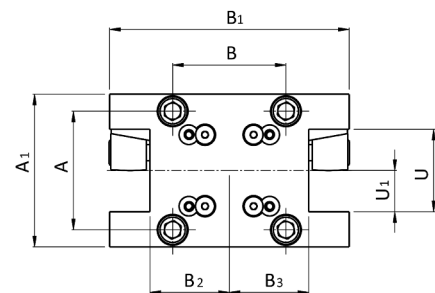
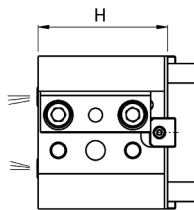
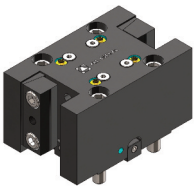

101/BMT65		Codice code - code - Bestell Nr.	U	U1	U2	H	H1	H2	H3	A	B	A1	B1	A2	B2	B3
 	E10/U 25 T65X80		50	25		80				73	70	94	121			
	E10/U 1" T65X80		2"	1"		80				73	70	94	121			



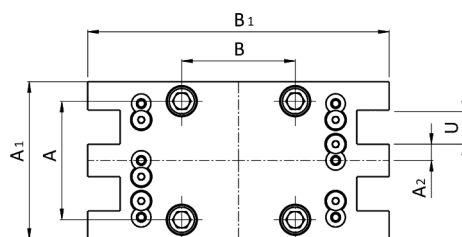
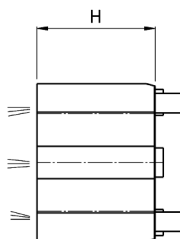

102/BMT65		Codice code - code - Bestell Nr.	U	U1	U2	H	H1	H2	H3	A	B	A1	B1	A2	B2	B3
 	E10/UD 25 T65X80		50	25		80				73	70	94	148		49	49
	E10/UD 1" T65X80		2"	1"		80				73	70	94	148		49	49



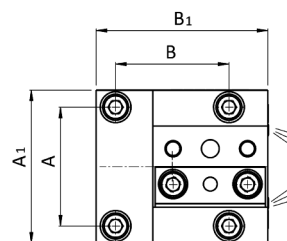
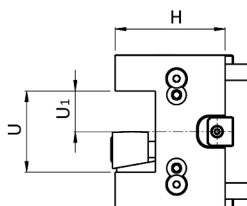

103/BMT65	Codice code - code - Bestell Nr.	U	U1	U2	H	H1	H2	H3	A	B	A1	B1	A2	B2	B3
  EXTERNAL	E10/UQ 20 T65X75	20			75				73	70	97	186	10		



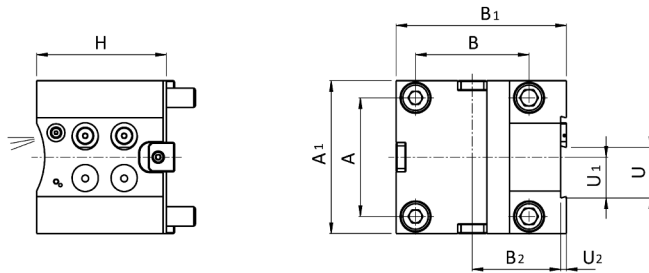

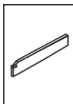
104/BMT65	Codice code - code - Bestell Nr.	U	U1	U2	H	H1	H2	H3	A	B	A1	B1	A2	B2	B3
  EXTERNAL	E10/UA 25 T65X70	50	25		70				73	70	94	106			
	E10/UA 1" T65X70	2"	1"		70				73	70	94	106			

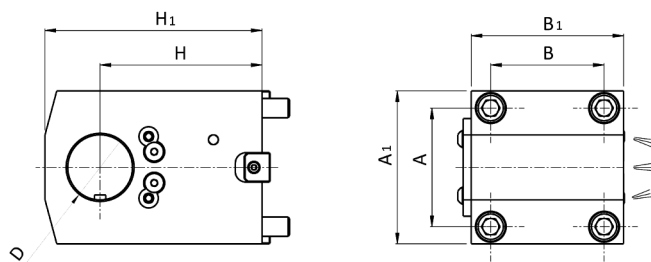

105/BMT65	Codice code - code - Bestell Nr.	U	U1	U2	H	H1	H2	H3	A	B	A1	B1	A2	B2	B3
  EXTERNAL	E10/TT 32 T65X80	32	25	2,36	80				73	70	94	105		54,5	

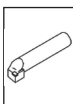

106/BMT65	Codice code - code - Bestell Nr.	d	d1	d2	H	H1	H2	H3	A	B	A1	B1	A2	B2	B3
  INT./EXT.	E10/B 40 T65X72	Ø 40			72	106			73	70	94	94			
	E10/B 50 T65X72	Ø 50			72	106			73	70	94	94			
	E10/B 1.5" T65X72	Ø 1.5"			72	106			73	70	94	94			
	E10/B 2" T65X72	Ø 2"			72	106			73	70	94	94			
	E10/B 40 T65X100	Ø 40			100	134			73	70	94	94			
	E10/B 1.5" T65X100	Ø 1.5"			100	134			73	70	94	94			
	E10/B 40 T65X115	Ø 40			115	150			73	70	94	94			
	E10/B 1.5" T65X115	Ø 1.5"			115	150			73	70	94	94			

**La produzione:
il lavoro**Production:
work

La produzione viene sviluppata nella moderna struttura a temperatura controllata di Almenno San Salvatore, mentre negli stabilimenti di Brembilla (I-Bergamo) vengono effettuate le lavorazioni di montaggio ed assemblaggio di gruppi completi. La superficie coperta delle strutture è di mq. 15.000, dei quali mq. 1.000 sono adibiti agli uffici amministrativi, commerciali e tecnici. L'attività produttiva si svolge con l'utilizzo di impianti e macchinari CNC costantemente aggiornati alle nuove tecnologie ed in grado di sviluppare le seguenti lavorazioni:

- Asportazione di truciolo
- Elettroerosione
- Tornitura orizzontale e verticale
- Fresatura universale 5 assi
- Fresatura/tornitura
- Lappatura per fori e piani
- Rettifica in tondo interno ed esterno
- Rettifica in tangenziale oltre al montaggio di gruppi e sottogruppi completi.

The production is developed in the modern, temperature controlled facility in Almenno San Salvatore, with Brembilla factories there are the assembly operations and the assembly of complete groups. The facilities covered area is of 15,000 sqm., 1,000 sqm. of which are used for the administrative commercial and technical offices. The production cycle takes place with the use of CNC fixtures and equipment constantly updated with new technologies and able to develop the following machining:

- Chip machining
- Electroerosion
- Horizontal and vertical turning
- 5-axis universal milling
- Milling/turning
- Lapping for holes and plane surfaces
- Cylindrical internal and external grinding
- Tangential grinding in addition to the assembly of complete groups and subassemblies.

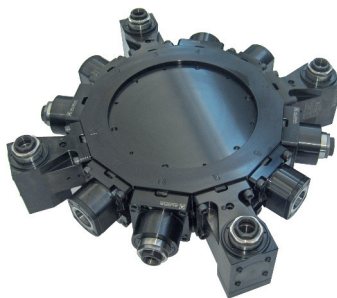
**Certificazioni:
uno standard
qualitativo**Certification:
a quality
standard

La tecnologia avanzata svolge un ruolo chiave nell'obiettivo di incrementare il proprio valore, quello dei propri prodotti, dei servizi e della capacità del personale, operando nel rispetto delle norme UNI EN ISO 9001:2008 e ISO 14001:2004. L'alto livello di sensibilità verso il rispetto delle regole di sicurezza e dell'ambiente è presente ed immediatamente percepito in tutte le strutture aziendali.

Advanced technology plays a key role aiming to increase its value and the products, services and staff capacity value, operating in compliance with UNI EN ISO 9001:2008 and ISO 14001:2004.

The high level of sensitivity towards the observance of safety rules and the environment is present and perceived immediately in all facilities.



UNI EN ISO 9001:2008 - Cert. n° 0141



UNI EN ISO 14001:2004 - Cert. n° 0270A



ALGRA S.p.A. Divisione accessori
Via Manzoni, 41 24031 Almenno S. Salvatore (BG)
Tel. +39 035.64.20.51 • Fax +39 035.64.01.28
algra.accessori@algra.it - www.algra.it