

8 7 6 5 4 3 2 1

MATERIAL: 6061 ALUMINUM ANODIZED

R96-V75100T4

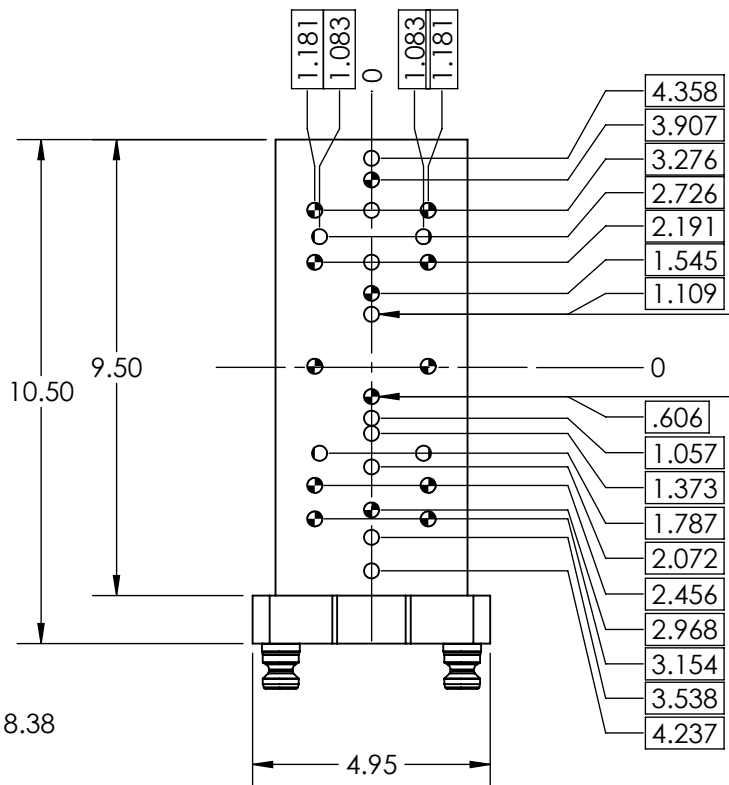
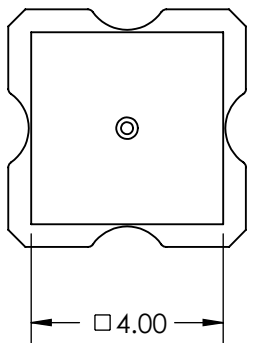
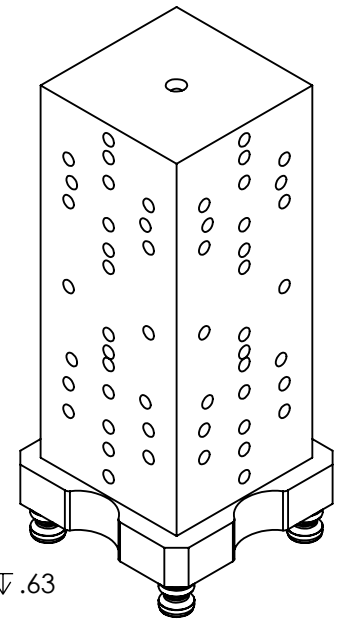

13X M8X1.25 ∇ .63
 14X Ø .3159 \pm .0003 ∇ .45
 FITS LP8

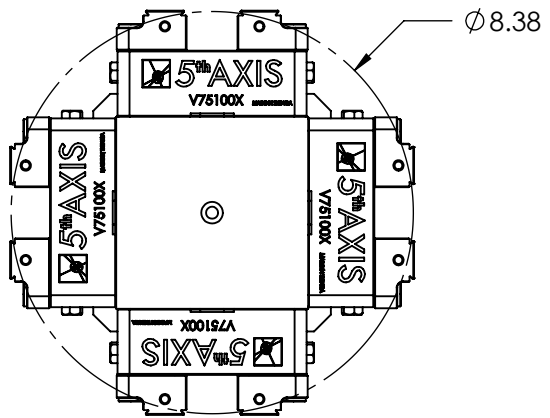



INCH DRAWN IN ACCORDANCE WITH ASME Y14.5-2009 PROPRIETARY AND CONFIDENTIAL THE INFORMATION CONTAINED IN THIS DRAWING IS THE SOLE PROPERTY OF FIFTH AXIS, INC. ANY REPRODUCTION IN PART OR AS A WHOLE WITHOUT THE WRITTEN PERMISSION OF FIFTH AXIS, INC. IS PROHIBITED.	TOLERANCES UNLESS OTHERWISE SPECIFIED X \pm 0.1 .XX \pm 0.01 X \pm 0.05 .XXX \pm 0.005 ANGULAR \pm 0.5° THIRD ANGLE PROJECTION	APPROVALS DRAWN BY Y. RHEE 09/12/2019 MANUFACTURING QUALITY FINAL	WWW.5THAXIS.COM 7140 ENGINEER ROAD SAN DIEGO, CA 92111 P (858) 505-0432 F (858) 505-9344	
	DESCRIPTION ROCKLOCK 96MM TOMBSTONE, 4 SIDED, V75100X			
	SIZE A	PART NO. R96-V75100T4		REV A
	DO NOT SCALE DRAWING SCALE 1:4 WEIGHT: 16.5 LBS SHEET 1 OF 2			

8 7 6 5 4 3 2 1

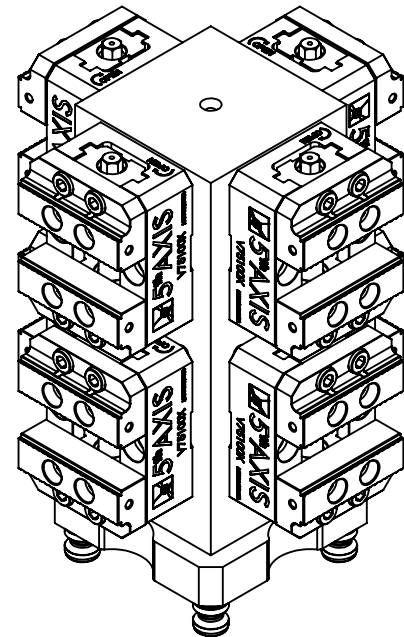
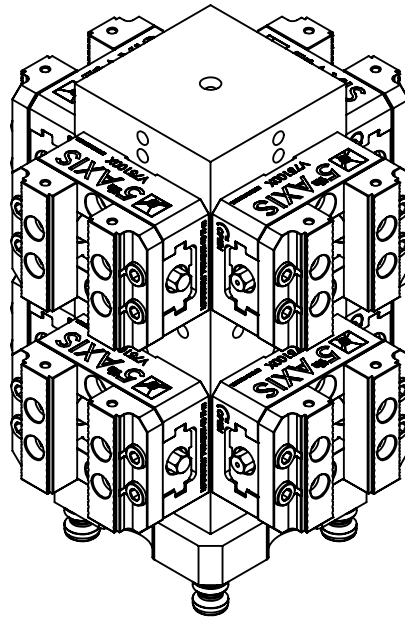
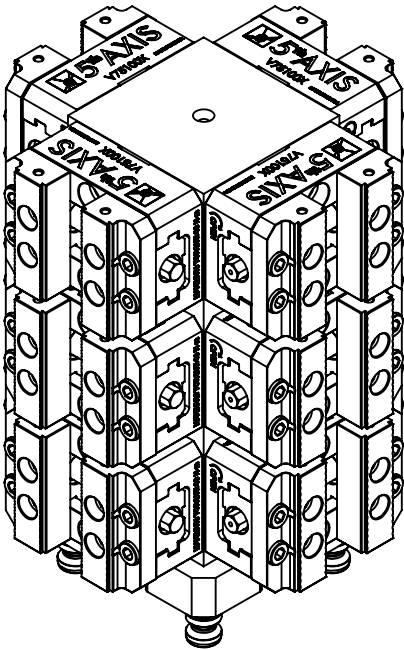
CONFIGURATIONS OF R96-V75100T4



INCH	TOLERANCES <small>UNLESS OTHERWISE SPECIFIED</small>		APPROVALS		 5thAXIS	<small>WWW.5THAXIS.COM</small> 7140 ENGINEER ROAD SAN DIEGO, CA 92111 P (858) 505-0432 F (858) 505-9344		
	<small>DRAWN IN ACCORDANCE WITH ASME Y14.5-2009</small>		<small>X ± 0.1</small>	<small>.XX ± 0.01</small>			<small>DRAWN BY</small> Y. RHEE	<small>09/12/2019</small>
	PROPRIETARY AND CONFIDENTIAL		<small>X ± 0.05</small>	<small>.XXX ± 0.005</small>			<small>MANUFACTURING</small>	
			<small>ANGULAR ± 0.5°</small>				<small>QUALITY</small>	
<small>THE INFORMATION CONTAINED IN THIS DRAWING IS THE SOLE PROPERTY OF FIFTH AXIS, INC. ANY REPRODUCTION IN PART OR AS A WHOLE WITHOUT THE WRITTEN PERMISSION OF FIFTH AXIS, INC. IS PROHIBITED.</small>		<small>THIRD ANGLE PROJECTION</small>		<small>FINAL</small>		DESCRIPTION ROCKLOCK 96MM TOMBSTONE, 4 SIDED, V75100X		
				<small>SIZE</small> A			<small>PART NO.</small> R96-V75100T4	<small>REV</small> A
		<small>DO NOT SCALE DRAWING</small>		<small>SCALE 1:4</small>	<small>WEIGHT: 16.5 LBS</small>			