

# NOTES:

1. PROGRAM DOVETAIL CUTTER TO CUT TO "B" FROM THE PART CENTERLINE
2. PROGRAM .010" EDGE BREAK ON DOVETAIL POINT
3. PROGRAM DOVETAIL CUTTER TO CUT TO DIMENSION "C", ROUGHING CUTTER SHOULD LEAVE .003 MIN STOCK
4. DIMENSION "C" IS THE MOST CRITICAL DIMENSION, DIMENSIONS "A" AND "B" WILL CHANGE DEPENDING ON YOUR STOCK SIZE.

# WISE DOVETAIL STOCK PREPARATION

WORKS WITH ALL 5TH AXIS VISES

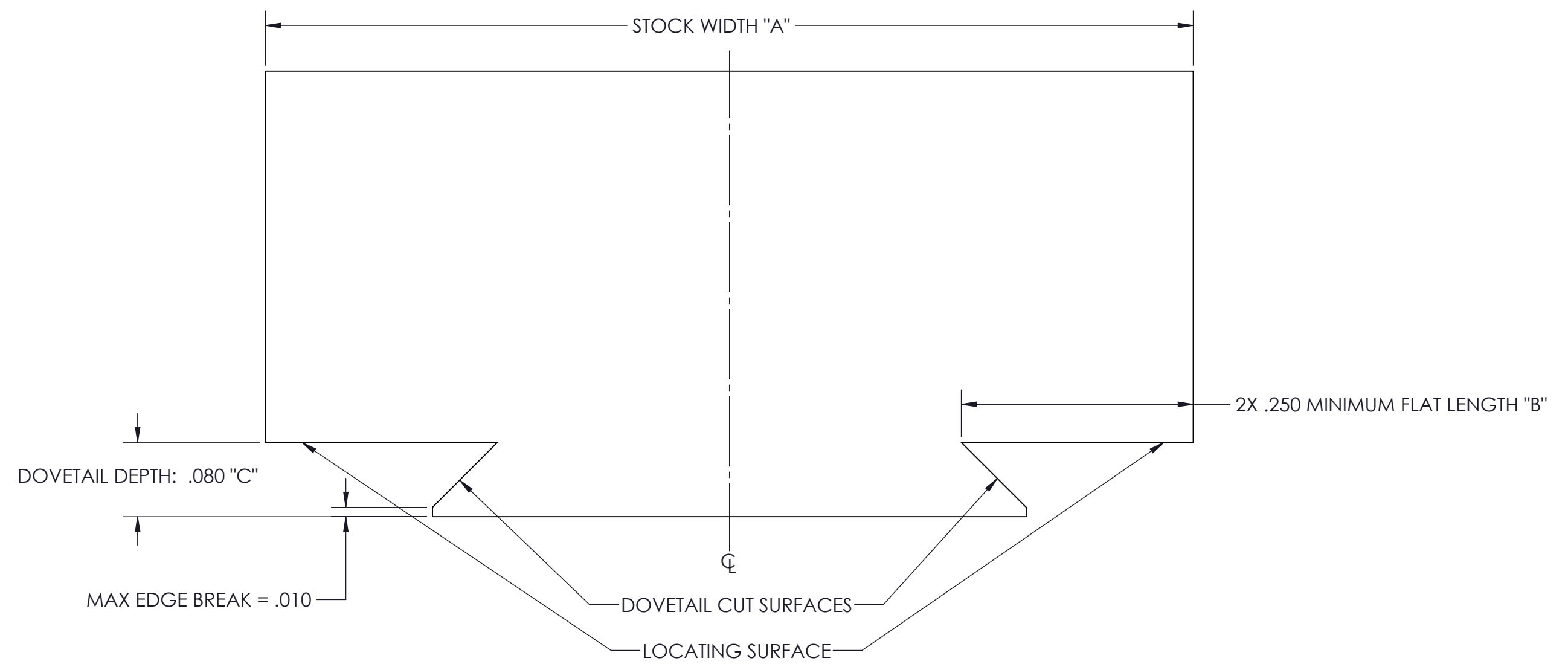

<b>INCH</b> <small>DRAWN IN ACCORDANCE WITH ASME Y14.5-2009</small> <b>PROPRIETARY AND CONFIDENTIAL</b>	<b>TOLERANCES</b> <small>UNLESS OTHERWISE SPECIFIED</small>			<small>WWW.FIFTHAXIS.COM</small> 7140 ENGINEER ROAD SAN DIEGO, CA 92111 P (858) 505-0432 F (858) 505-9344
	<small>X ± 0.1 .XX ± 0.01</small> <small>.X ± 0.05 .XXX ± 0.005</small> <small>ANGULAR ± 0.5°</small>	<small>THIRD ANGLE PROJECTION</small> 		
<small>THE INFORMATION CONTAINED IN THIS DRAWING IS THE SOLE PROPERTY OF FIFTH AXIS, INC. ANY REPRODUCTION IN PART OR AS A WHOLE WITHOUT THE WRITTEN PERMISSION OF FIFTH AXIS, INC. IS PROHIBITED.</small>	SIZE <b>B</b>	PART NO. <b>DSP-V</b>	REV <b>A</b>	<small>DO NOT SCALE DRAWING</small>



# PROPER DOVETAIL

MATERIAL SHOULD REST ON TOP OF THE JAW / FIXTURE AND ON THE 45° FACE.

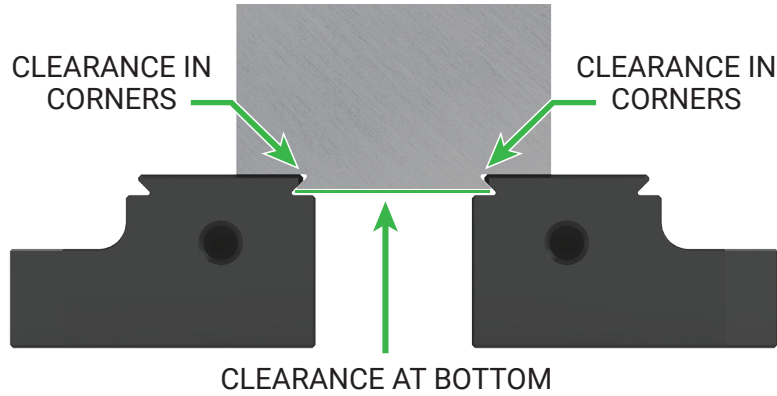

When a **proper** dovetail is used, jaw/dovetail fixture **acts as a wedge** trying to split the material in the corner.

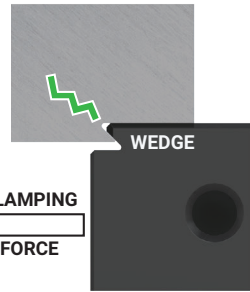

Material is clamped only once or twice and is therefore resistant to fracturing.

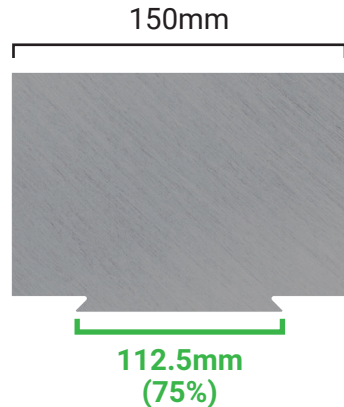

We recommend dovetail width should not be **less than** 75% of the width of the stock.

This is a **general ratio, not a rule**. If in doubt, stick to 75%.

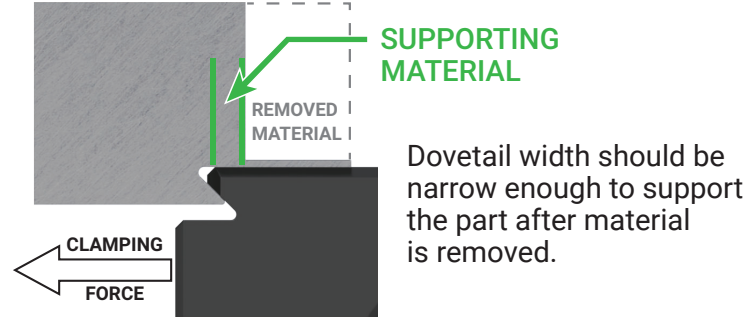

THERE IS NO SIMPLE ANSWER TO HOW MUCH SUPPORT IS NEEDED.

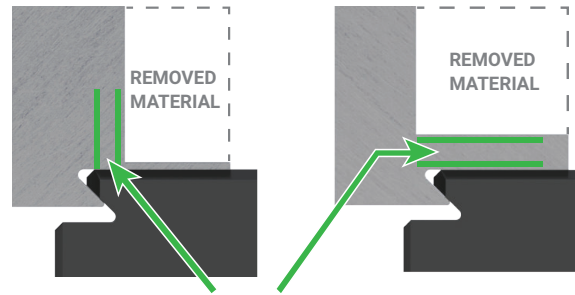

**SUPPORTING MATERIAL**

If more support is needed, **Decrease dovetail width or increase tab thickness**

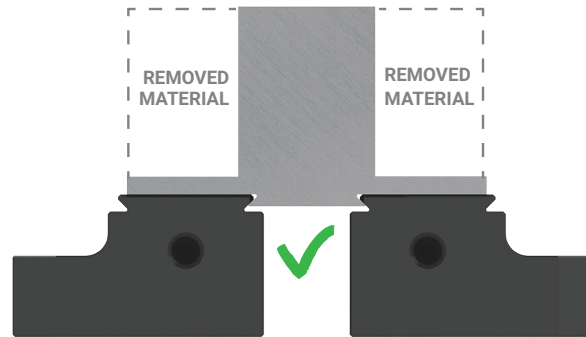

For narrow parts, position the dovetail as close as possible to the **finished part's** center of mass.



# COMMON MISTAKES

## 1. DOVETAIL TOO DEEP

Clamping with a dovetail should **never** cause the material to locate on the bottom step of the jaw.

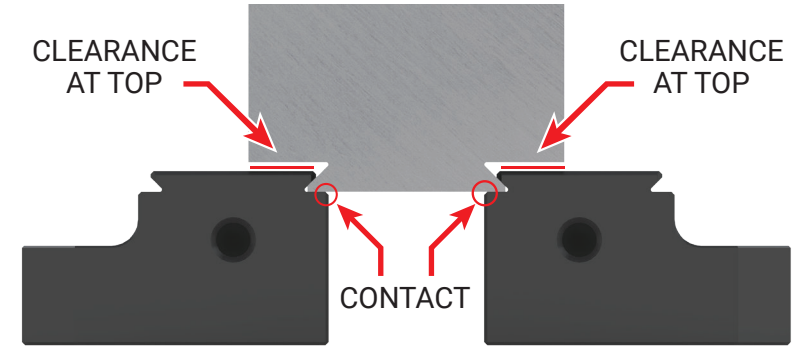

Locating on bottom step causes material to become a wedge trying to split the jaw. **This can break the jaw!**

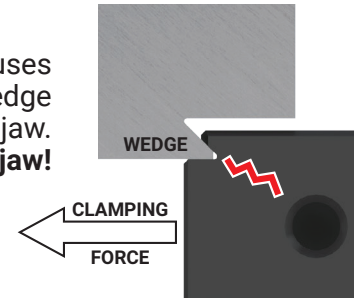

## 2. FINISHED PART UNSUPPORTED

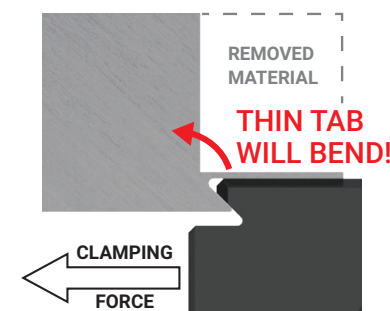

A thin tab and/or insufficient material on the top locating surface will allow the part to move during machining.

**✘ 3. OVERSIZED CORNER RADIUS**

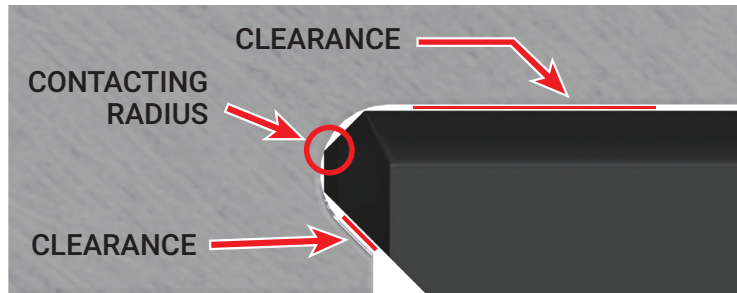

An overly wide inside corner radius allows material to contact the corner of the jaw, preventing it from locating correctly.

**This will call excessive vibration during machining.**

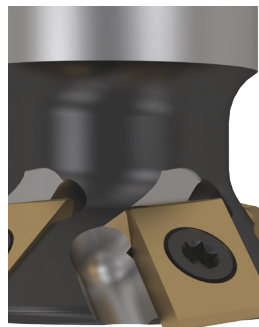

This issue is caused when dovetail cutter inserts / flutes are worn or broken.

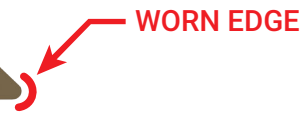

**✘ 4. EXCESSIVELY WIDE DOVETAIL**

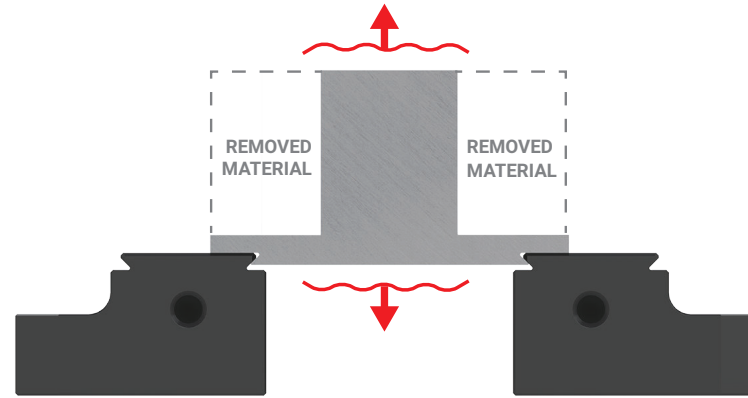

Even though this part has tabs thick enough to prevent breaking, the dovetail is not properly positioned under the part. This may result in excessive vertical vibration.

**✘ 5. EXCESSIVELY NARROW DOVETAIL**

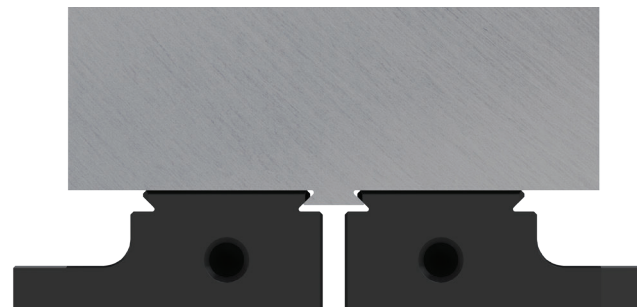

Excessively narrow dovetail will concentrate support at the center of the stock and potentially cause chatter.

Keep in mind how and where force is applied to stock during machining.



---

# DOVETAIL TROUBLESHOOTING GUIDE

---



The information in this document is applicable to ALL 5th Axis™ products with a dovetail feature.

Both vises **AND** dovetail fixtures should follow these rules.